



Coimisiún na Scrúduithe Stáit
State Examinations Commission

Leaving Certificate Examination 2022

Mathematics

Paper 2

Ordinary Level

Monday 13 June Morning 9:30 - 12:00

220 marks

Examination Number

<input type="text"/>	<input type="text"/>	<input type="text"/>	<input type="text"/>	<input type="text"/>	<input type="text"/>
----------------------	----------------------	----------------------	----------------------	----------------------	----------------------

Day and Month of Birth

<input type="text"/>	<input type="text"/>	<input type="text"/>	<input type="text"/>
----------------------	----------------------	----------------------	----------------------

For example, 3rd February
is entered as 0302

Centre Stamp

Do not write on this page

Instructions

There are **two** sections in this examination paper.

Section A	Concepts and Skills	120 marks	6 questions
Section B	Contexts and Applications	100 marks	4 questions

Answer questions as follows:

- any **four** questions from Section A – Concepts and Skills
- any **two** questions from Section B – Contexts and Applications.

Write your Examination Number in the box on the front cover.

Write your answers in blue or black pen. You may use pencil in graphs and diagrams only.

This examination booklet will be scanned and your work will be presented to an examiner on screen. Anything that you write outside of the answer areas may not be seen by the examiner.

Write all answers into this booklet. There is space for extra work at the back of the booklet. If you need to use it, label any extra work clearly with the question number and part.

The superintendent will give you a copy of the *Formulae and Tables* booklet. You must return it at the end of the examination. You are not allowed to bring your own copy into the examination.

You will lose marks if your solutions do not include relevant supporting work.

You may lose marks if you do not include appropriate units of measurement, where relevant.

You may lose marks if you do not give your answers in simplest form, where relevant.

Write the make and model of your calculator(s) here:

- (b) The diagram below shows two circles, s and t . The circle s has centre $(22, 13)$. The two circles touch at the point $(12, 11)$.

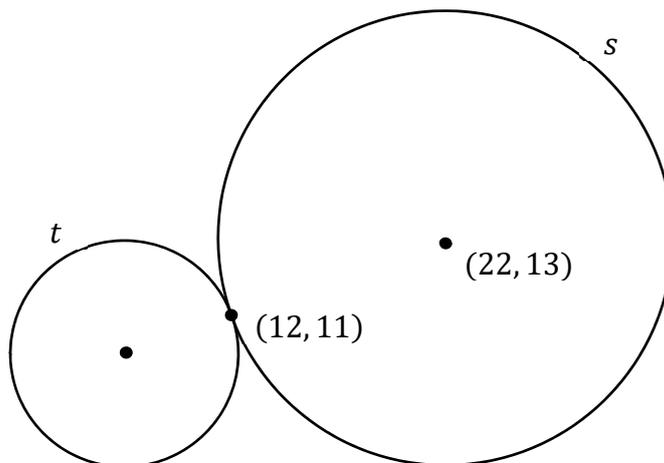

- (i) Find the co-ordinates of another point on the circle s , **other than** $(12, 11)$.



- (ii) The radius of the circle t is **half** the radius of s . Find the co-ordinates of the centre of the circle t .

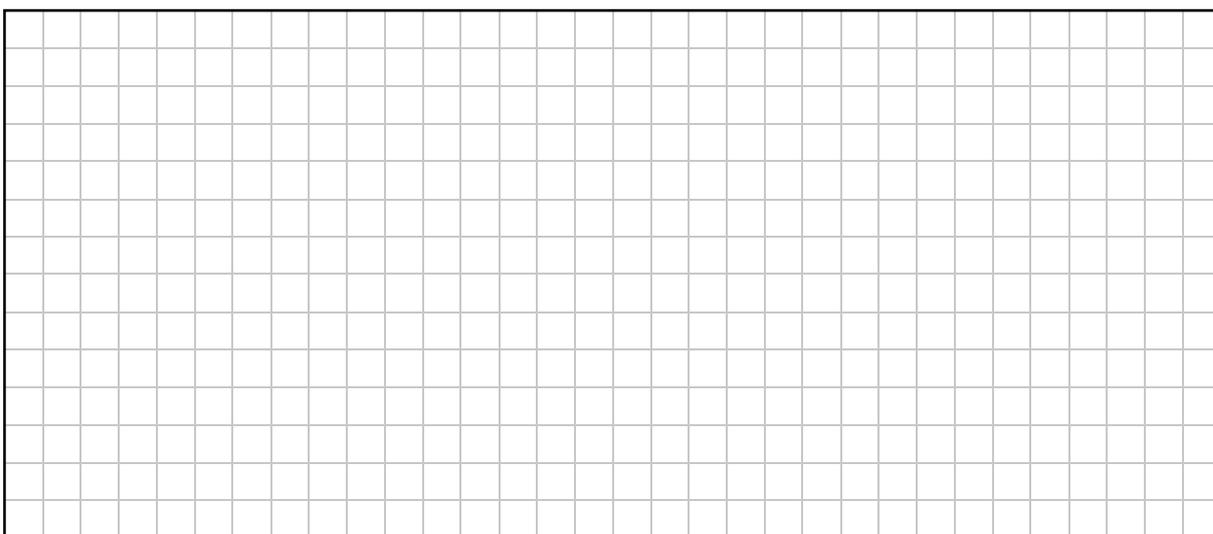

Question 3

(30 marks)

(a) A list of 7 numbers is shown below.

17, 8, 9, 8, 14, 11, 28

(i) Find the mean of these 7 numbers, correct to 1 decimal place.

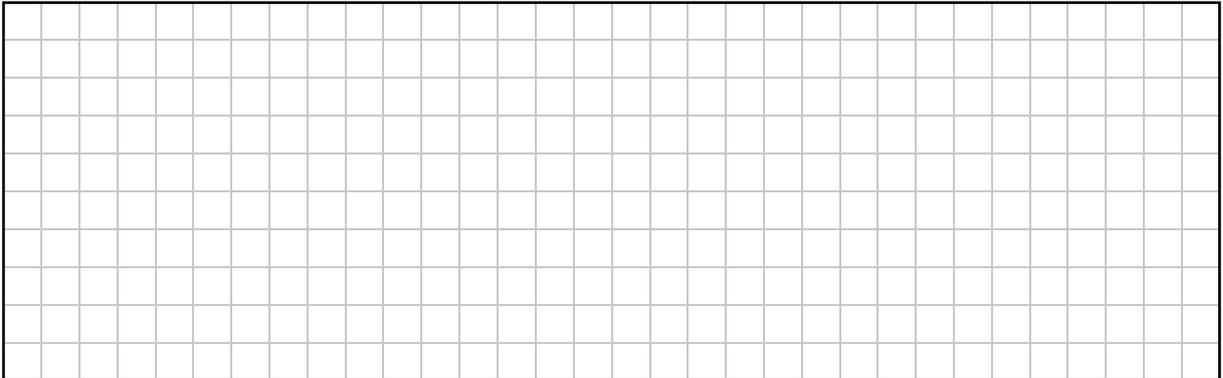

(ii) Find the median of these 7 numbers.

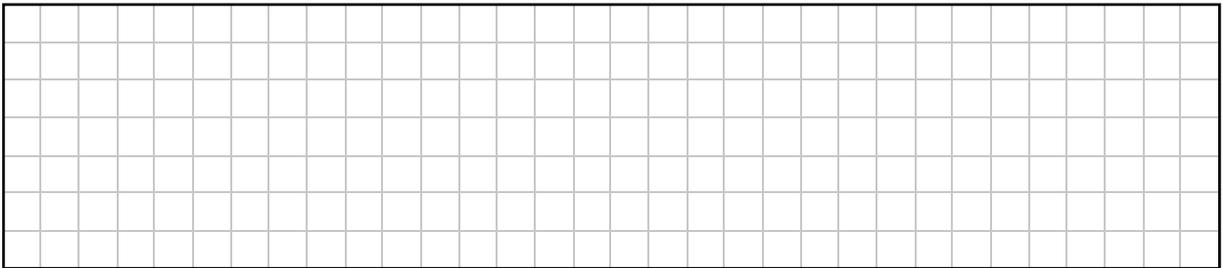

(iii) One more number is added to the list. The new median is 10.5.
Find the number that was added to the list.

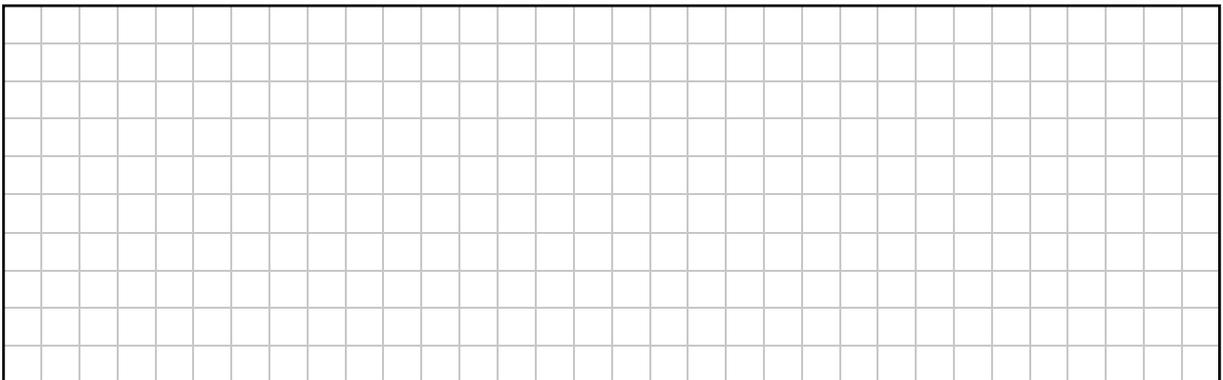

- (b) Ben has to choose three subjects to study.
He must pick one subject from each of these three groups:

Group A (3 subjects)	Group B (4 subjects)	Group C (5 subjects)
French Spanish German	Biology Physics Chemistry Business	Art Accounting History Geography Home Economics

- (i) How many different choices of three subjects can Ben make, picking one from each group?

--

- (ii) The school is going to add one extra subject to one of these groups (A, B, or C).
Which group should the extra subject be added to, in order to make the number of different choices of three subjects that Ben can make as **large** as possible?
Justify your answer.

Answer:
Justification:

Question 4

(30 marks)

- (a) A group of students sat an exam. Each student was given a grade. The following table shows how many students got each grade.

Grade	Distinction	High Merit	Merit	Achieved
Number of students	8	12	39	13

Complete the pie chart below to show this information. Label each sector clearly. Show your working out.

The sector for Distinction is already given. It has an angle of 40° .

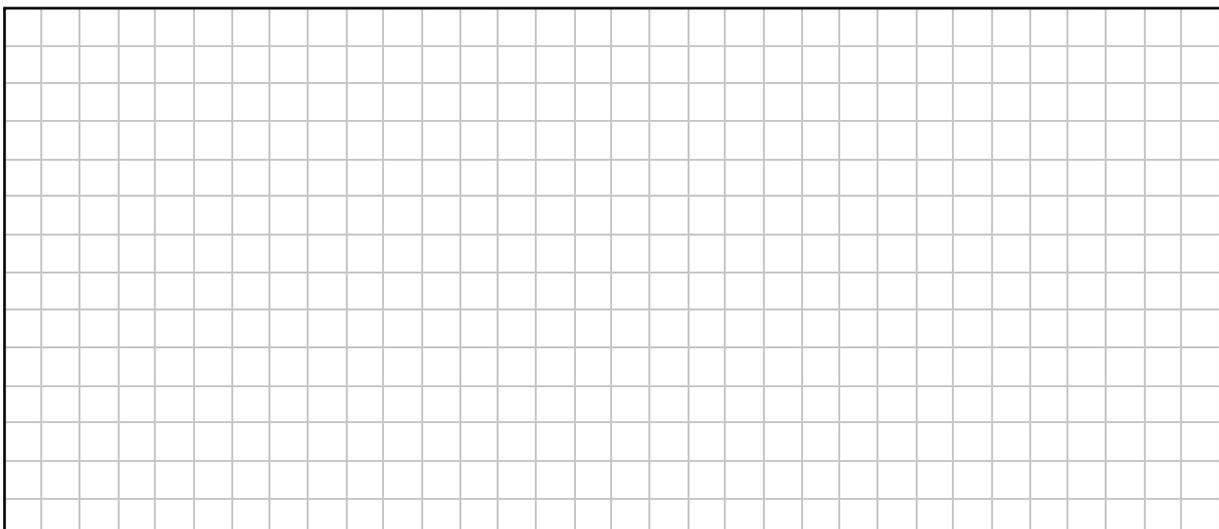
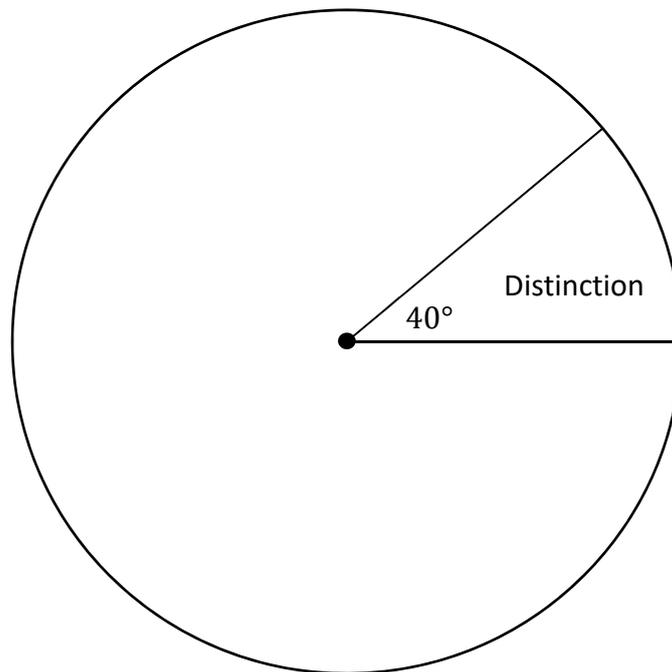

Question 5

(30 marks)

An equilateral triangle PQR has sides of length 8 cm.

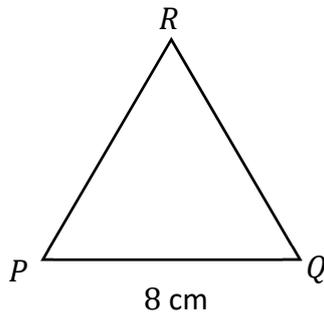

- (a) (i) Write down the size of the angle $\angle PQR$.

--

- (ii) Show that the area of the triangle PQR is $16\sqrt{3}$ cm².

--

- (iii) Hence, or otherwise, find the perpendicular height of the triangle PQR , taking PQ as the base. Give your answer in the form $a\sqrt{b}$ cm, where $a, b \in \mathbb{N}$.

--

(b) GHK is a right-angled triangle. $\angle GHK = 90^\circ$, $|GH| = 12$ cm, and $|GK| = 30$ cm.

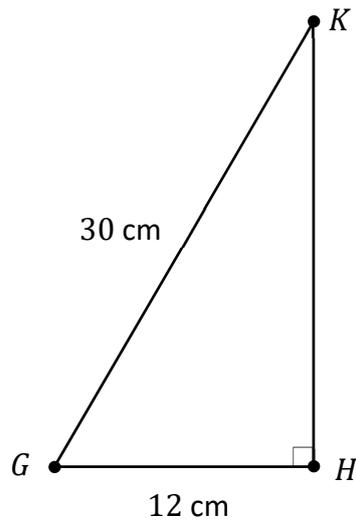

Using the theorem of Pythagoras, find the distance $|HK|$.

Give your answer correct to 1 decimal place.

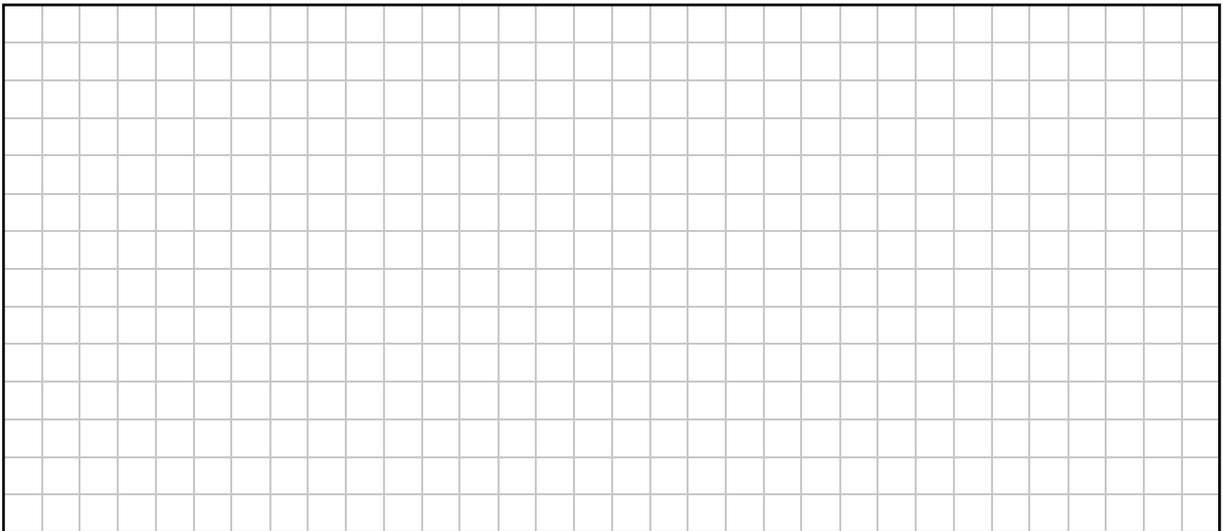

(b) Two statements, **A** and **B**, are shown below.

For each statement, put a tick (✓) in the correct box to show if it is true or false.
Give a reason for your answer in each case.

(i) **Statement A:** If two triangles are similar, then they **must** be congruent.

This statement is: true false
(tick **one** box only)

Reason: _____

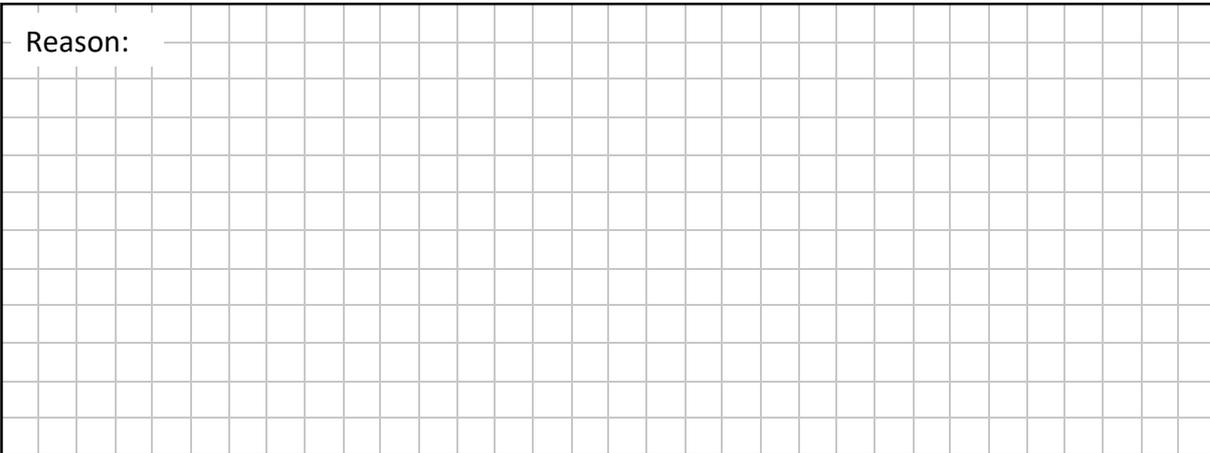

(ii) **Statement B:** If two triangles are congruent, then they **must** be similar.

This statement is: true false
(tick **one** box only)

Reason: _____

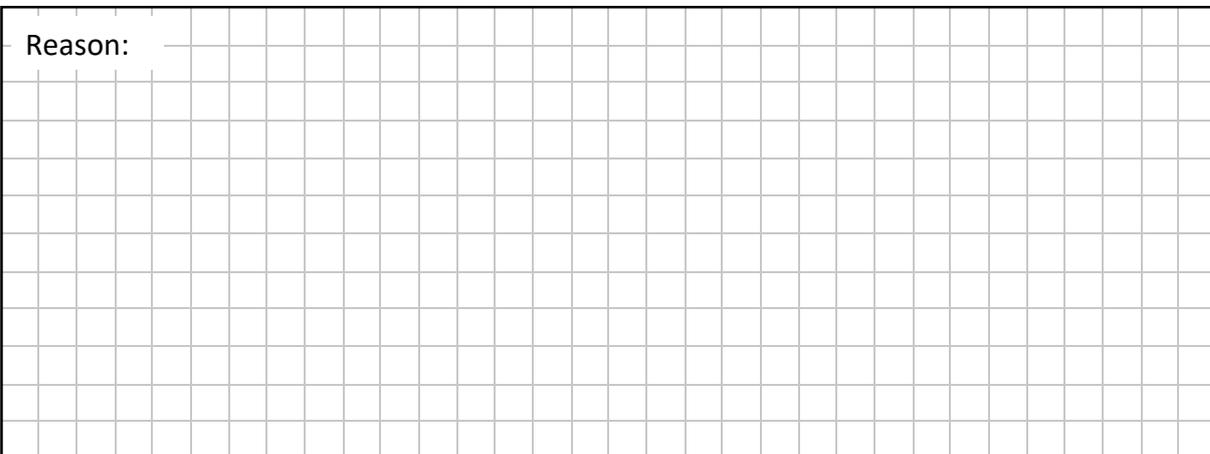

The table below shows the breakdown of the animals in the shelter, by type of animal (cat or dog) and by sex (male or female), on a particular Monday.

(b) Complete the table, by filling in the four missing values.

	Male	Female	Total
Cats	5	9	14
Dogs	11		
Total			40

Three different animals were picked at random from the animals in the shelter on this Monday.

(c) (i) Find the probability that the first animal picked was a cat.

(ii) Find the probability that all three animals picked were male dogs.
Give your answer correct to 3 decimal places.

- (d) The 9 female cats were put in 9 separate pens.
Work out the number of ways in which this could have been done
(that is, the number of different possible arrangements).

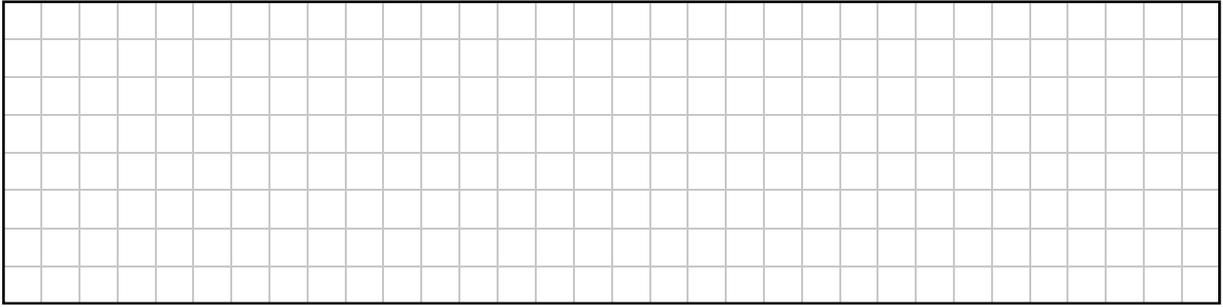

- (e) By the end of this week, 10 of the animals had left the shelter, and **no** new animals had been taken in. If an animal was picked at random at the end of this week, the probability of picking a dog would be $\frac{11}{15}$.

Work out how many cats left the shelter during this week.

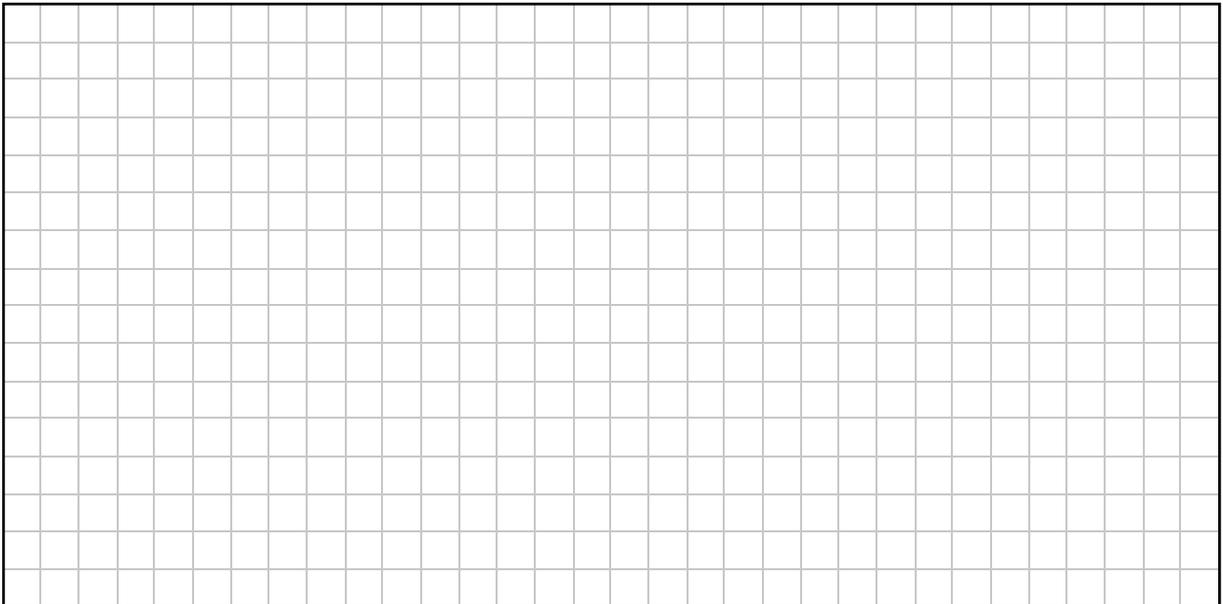

(c) Assume that the Fastnet lighthouse can be seen from anywhere within a circle of radius 50 km.

(i) Work out the area of the circle within which the Fastnet lighthouse can be seen.
Give your answer correct to the nearest km^2 .

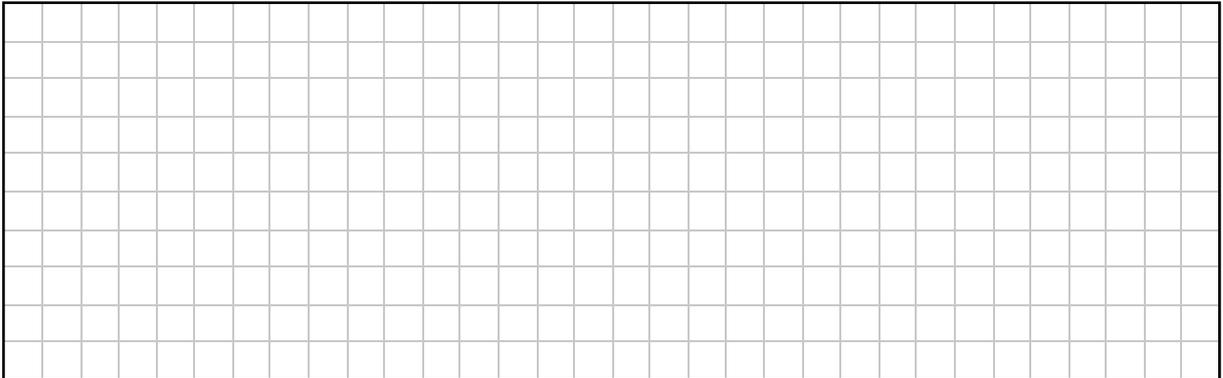

(ii) $50 \text{ km} = 27 \text{ nautical miles}$.
Use this to work out how many km are in 1 nautical mile.
Give your answer correct to 4 significant figures.

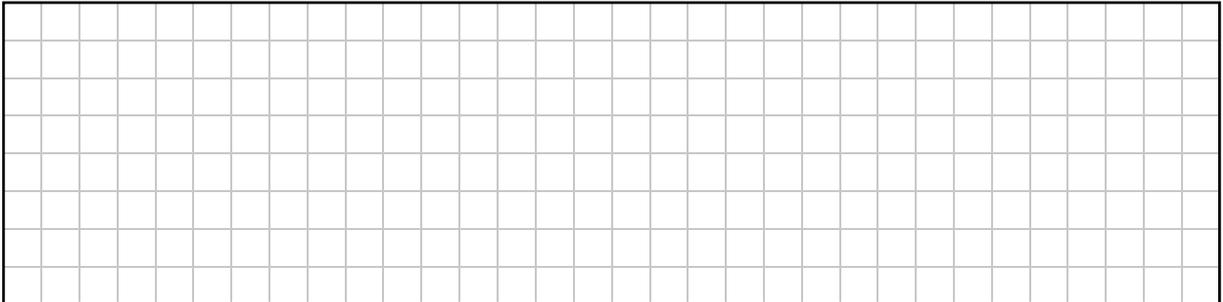

- (d) The top of the Fastnet lighthouse, F , is 49 m above sea level. The angle of elevation of the top of the lighthouse from a ship S is 1.2° , as shown in the diagram below (not to scale).
- Find the horizontal distance marked d below, from the ship to the base of the lighthouse. Give your answer in **kilometres**, correct to 2 decimal places.

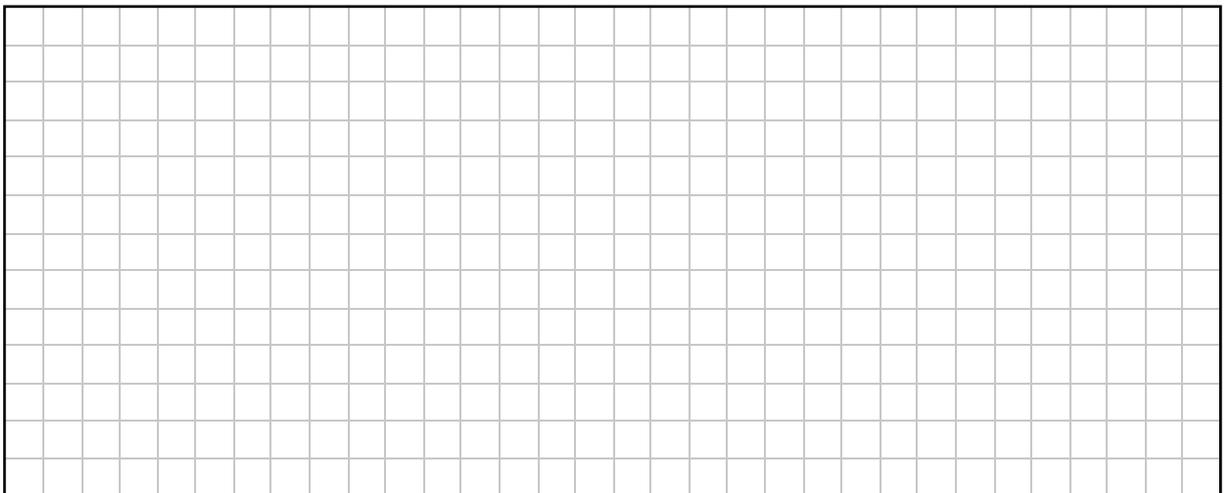
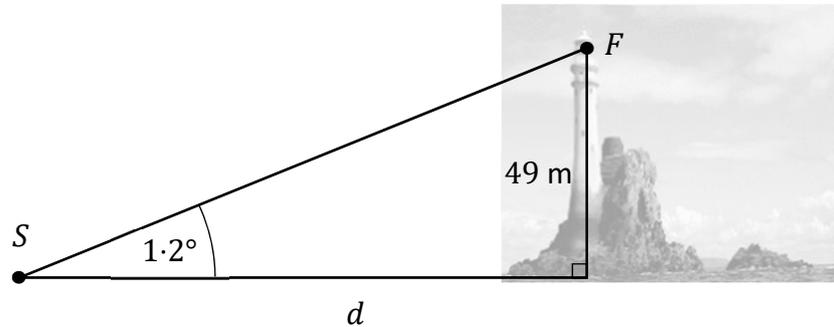

Source of image: roaringwaterjournal.com. Altered.

Question 9

(50 marks)

Seán has built a shed. The diagrams below show the dimensions of Seán’s shed.
 The shed is in the shape of a prism. Its front face is in the shape of a triangle on top of a rectangle.
 Its highest point is directly above the centre of its base.

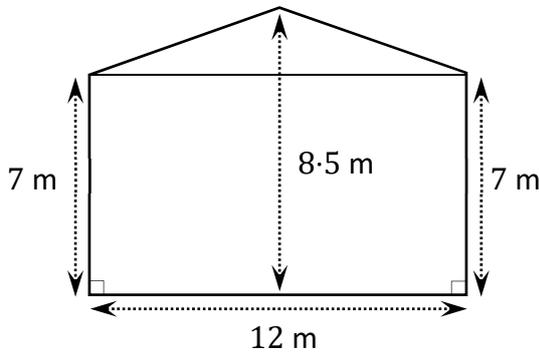

Front face of shed

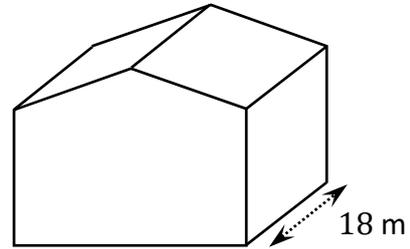

Diagram of whole shed

- (a) State which of the following statements is most likely to be true, **and** write down a possible height of Seán that would support your answer. Tick (✓) **one** box only.

The shed at the highest point is 3 times as high as Seán.

The shed at the highest point is 5 times as high as Seán.

The shed at the highest point is 8 times as high as Seán.

Possible height of Seán: _____

- (b) Seán says that his shed has a capacity of over one million litres, where $1 \text{ m}^3 = 1000$ litres. Work out the volume of Seán’s shed, to show that he is correct.

There is space for more work on the next page.

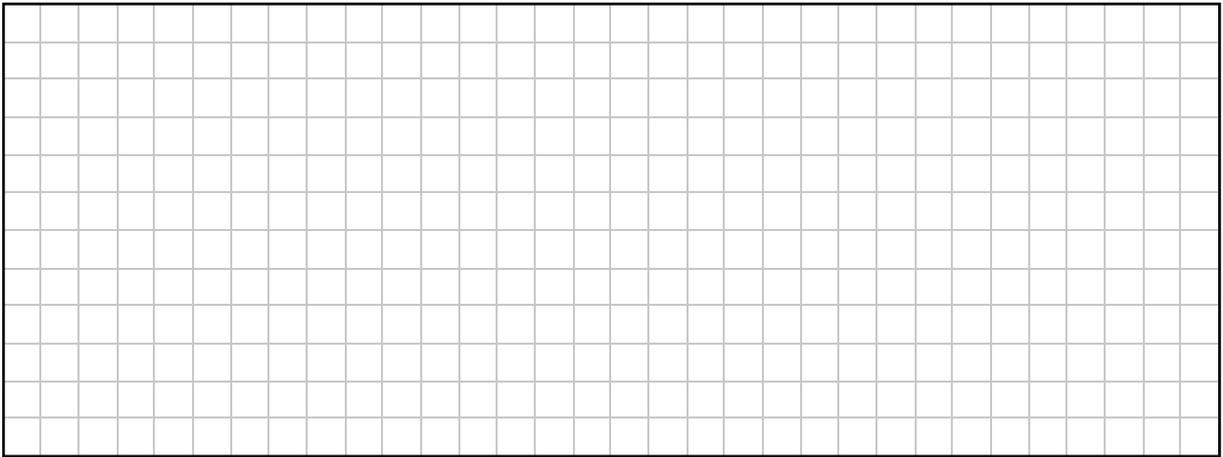

- (c) Use the theorem of Pythagoras to find the length of the distance marked d in the diagram below, the slant length of the roof. Give your answer in metres, correct to 1 decimal place.

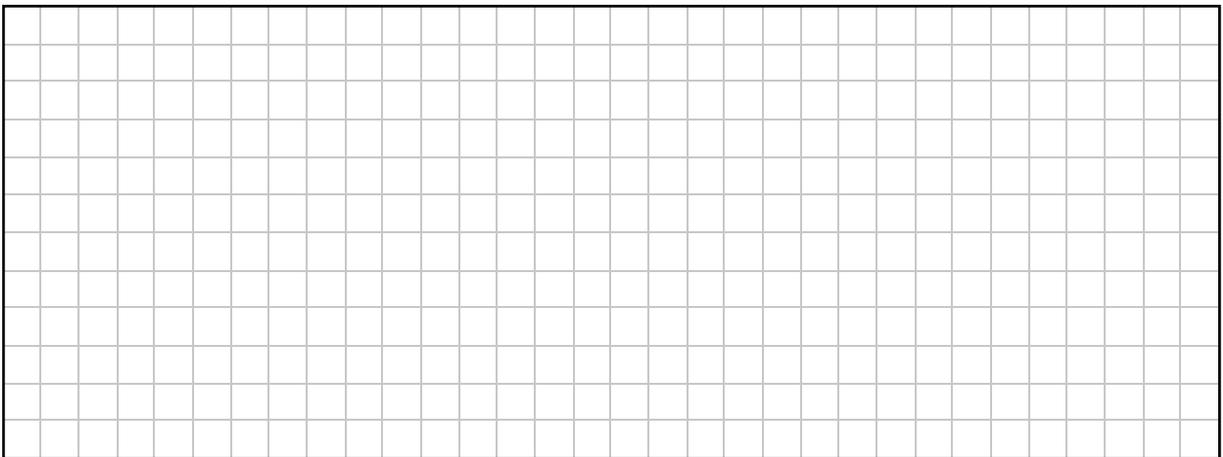
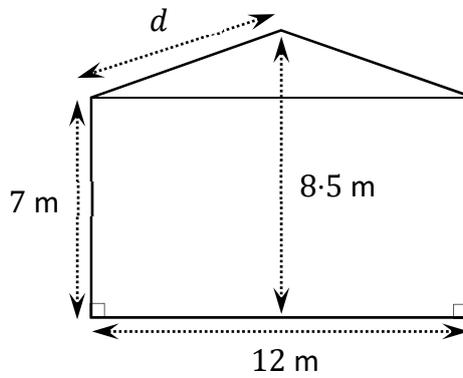

This question continues on the next page.

- (d) A scale diagram of the front of the shed is shown below.
One point on the diagram is marked **A**.

Construct an enlargement of the diagram below, with centre **A** and a scale factor of 3.
Show all of your construction lines clearly.

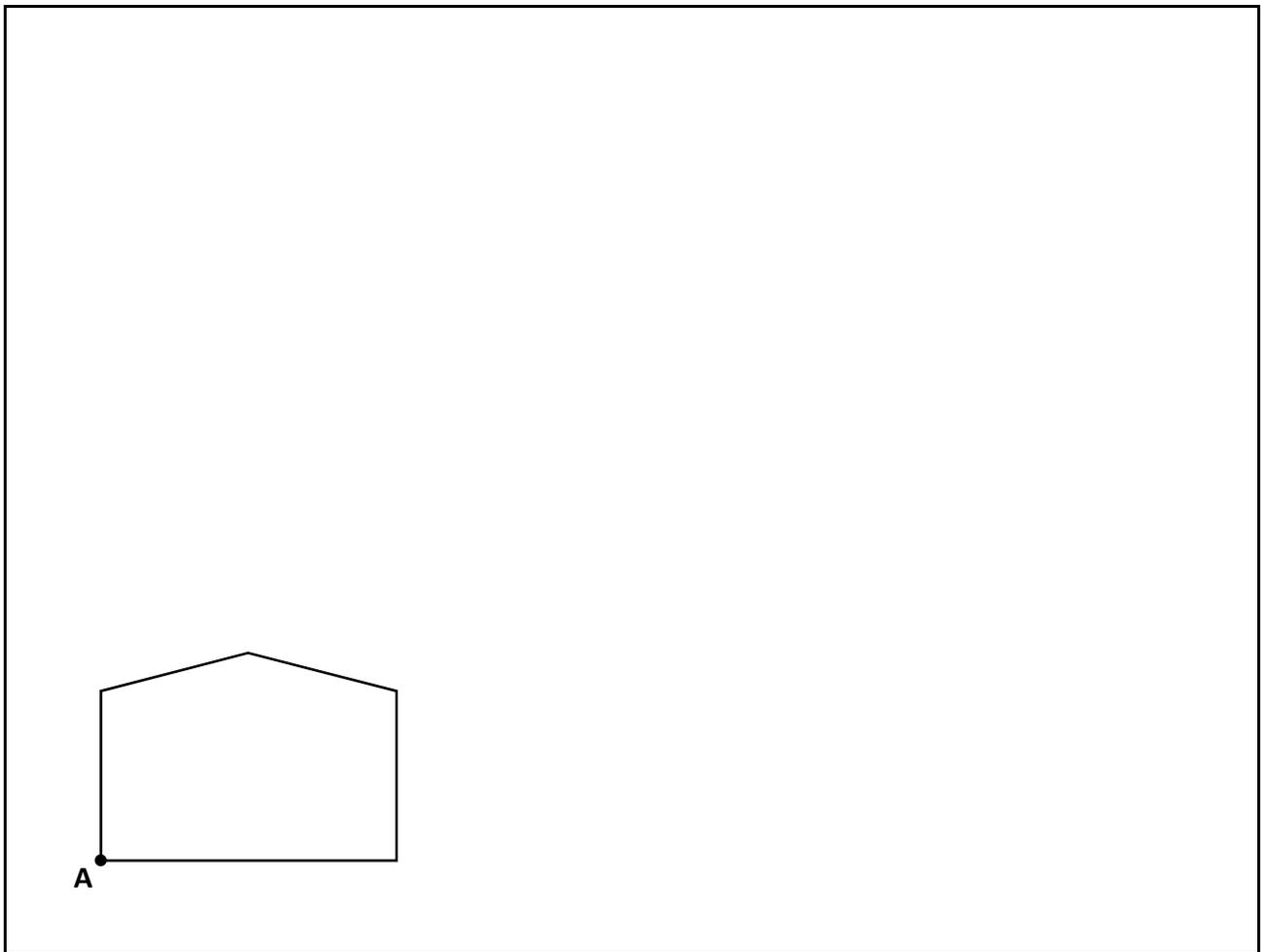

- (e) The diagram below shows part of the roof of a smaller shed (not to scale). Some measurements are marked on the diagram.

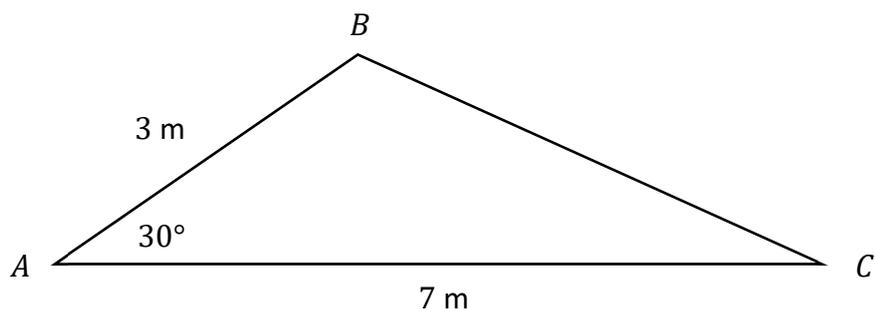

- (i) Show that $|BC| = 4.65$ m, correct to 2 decimal places.

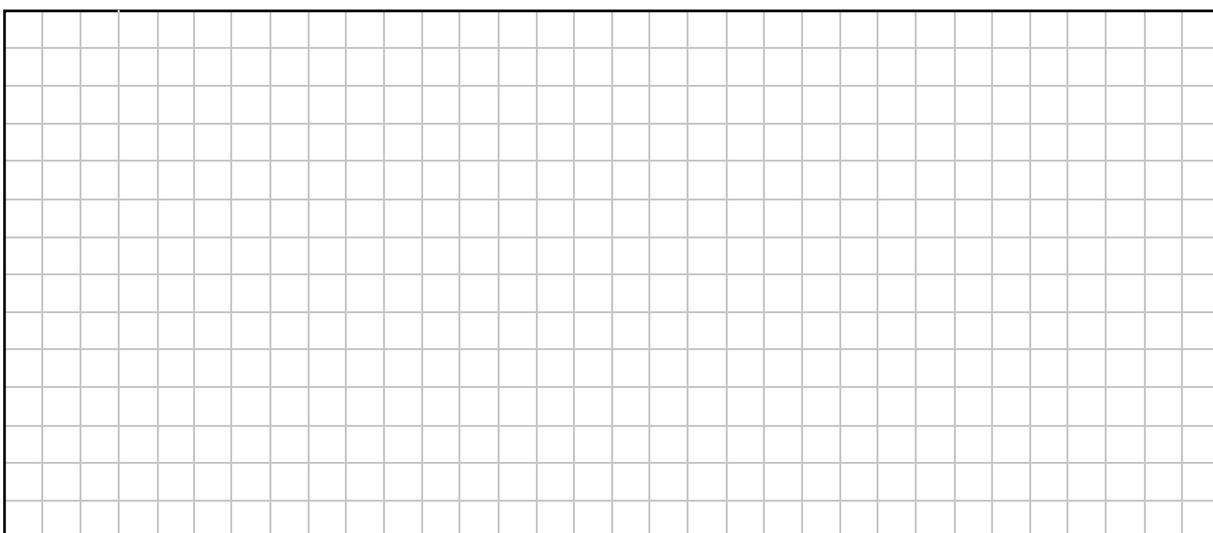

- (ii) Find $|\angle ACB|$, the angle that the roof makes at the point C.
Give your answer correct to the nearest degree.
Remember that $|BC| = 4.65$ m, correct to 2 decimal places.

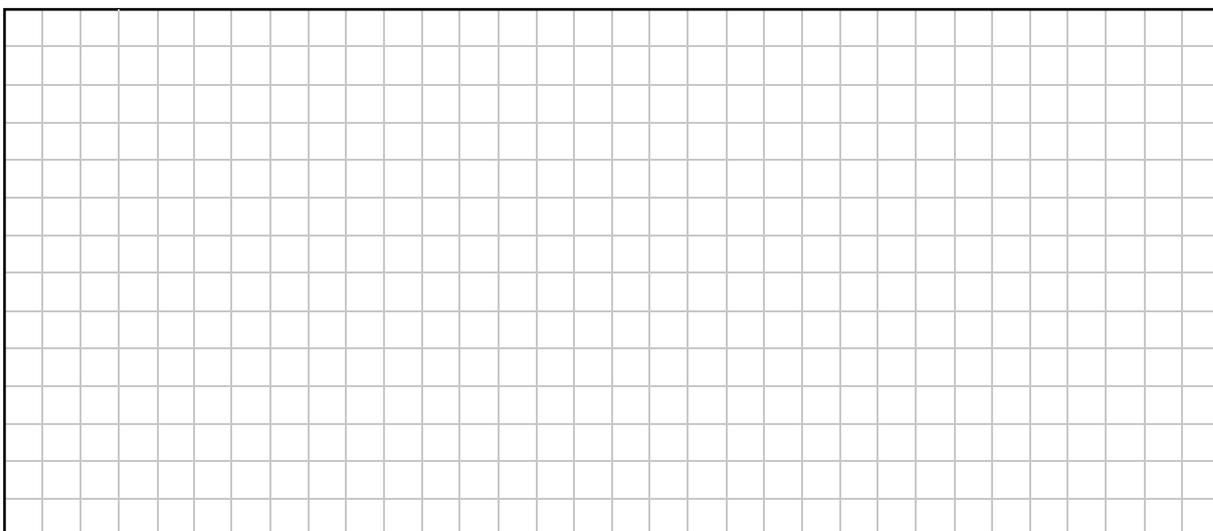

- (iii) Use the percentages given in (b)(i) and (b)(ii) to write down a 95% confidence interval for the percentage of all adults in Ireland who walk for recreation, in 2022.

--

- (iv) According to the *2019 Irish Sport Monitor Report*, 65% of the adults in Ireland walked for recreation.

Carry out a Hypothesis Test, at the 5% level of significance, to find out if this figure of 65% has changed in 2022, based on the results of the above survey. Clearly state your conclusion **and** give a reason for your conclusion.

Conclusion:
Reason:

- (c) Assume that 20% of adults in Ireland jog for recreation.
Three adults are picked at random.
Find the probability that exactly one of these adults jogs for recreation.

--

This question continues on the next page.

Sinéad is joining a gym. She will be able to use the gym, and also go to classes.

- (d) She could pay for individual classes, at €6 per class. Sinéad estimates that there is:
- a 30% chance she will go to no classes in the year,
 - a 60% chance she will go to 1 class a week, so 52 classes in a year, and
 - a 10% chance she will go to 2 classes a week, so 104 classes a year.

Use these figures to work out the expected value of the cost of the classes for a year.

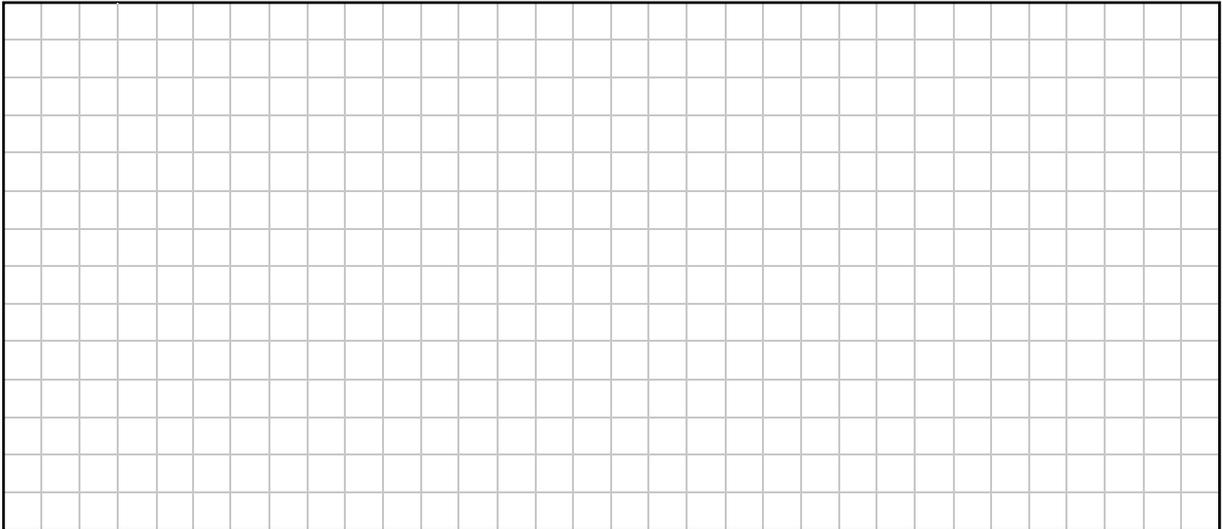

- (e) There are two price plans for the gym, **Silver** and **Gold**, as follows:

Silver	Gold
€420 for the year. Pay €6 for each class.	€670 for the year. All classes are free.

Work out the least number of classes that Sinéad would have to go to in a year, so that the **Gold** plan would cost less than the **Silver** plan.

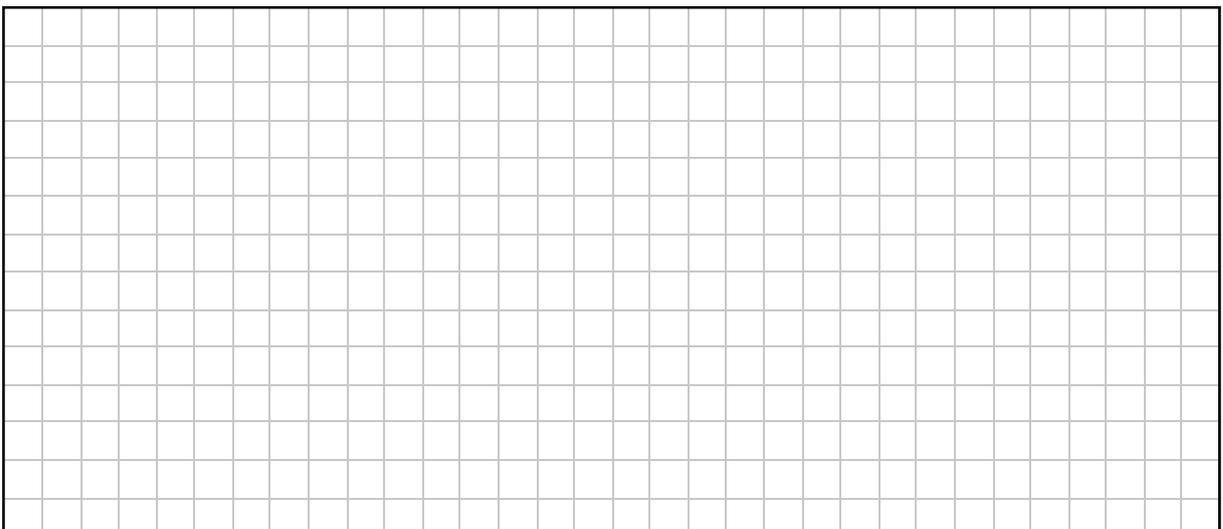

Page for extra work.

Label any extra work clearly with the question number and part.

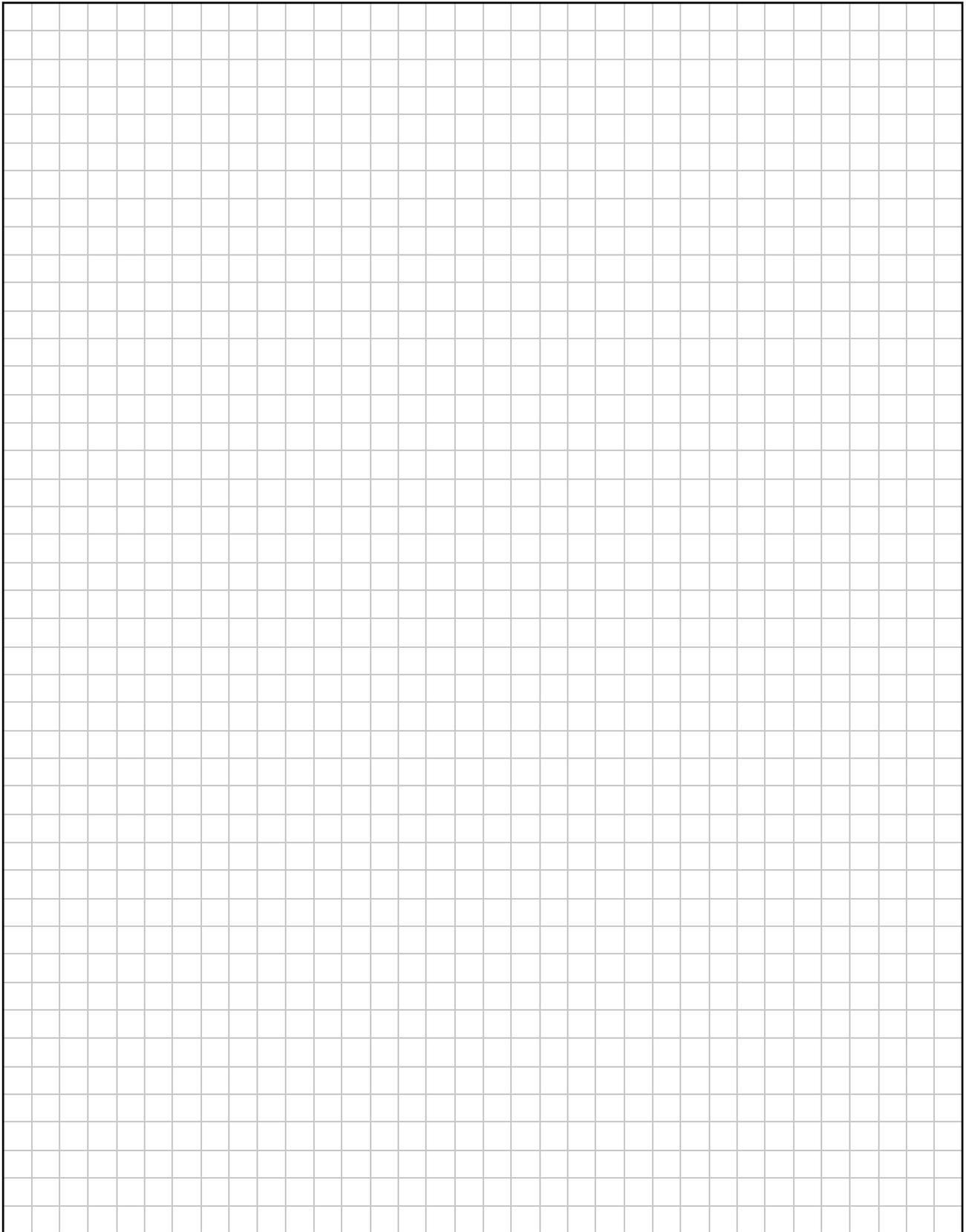

Do not write on this page

Copyright notice

This examination paper may contain text or images for which the State Examinations Commission is not the copyright owner, and which may have been adapted, for the purpose of assessment, without the authors' prior consent. This examination paper has been prepared in accordance with *Section 53(5) of the Copyright and Related Rights Act, 2000*. Any subsequent use for a purpose other than the intended purpose is not authorised. The Commission does not accept liability for any infringement of third-party rights arising from unauthorised distribution or use of this examination paper.

Leaving Certificate – Ordinary Level

Mathematics Paper 2

Monday 13 June

Morning 9:30 - 12:00